

FRONT VIEW

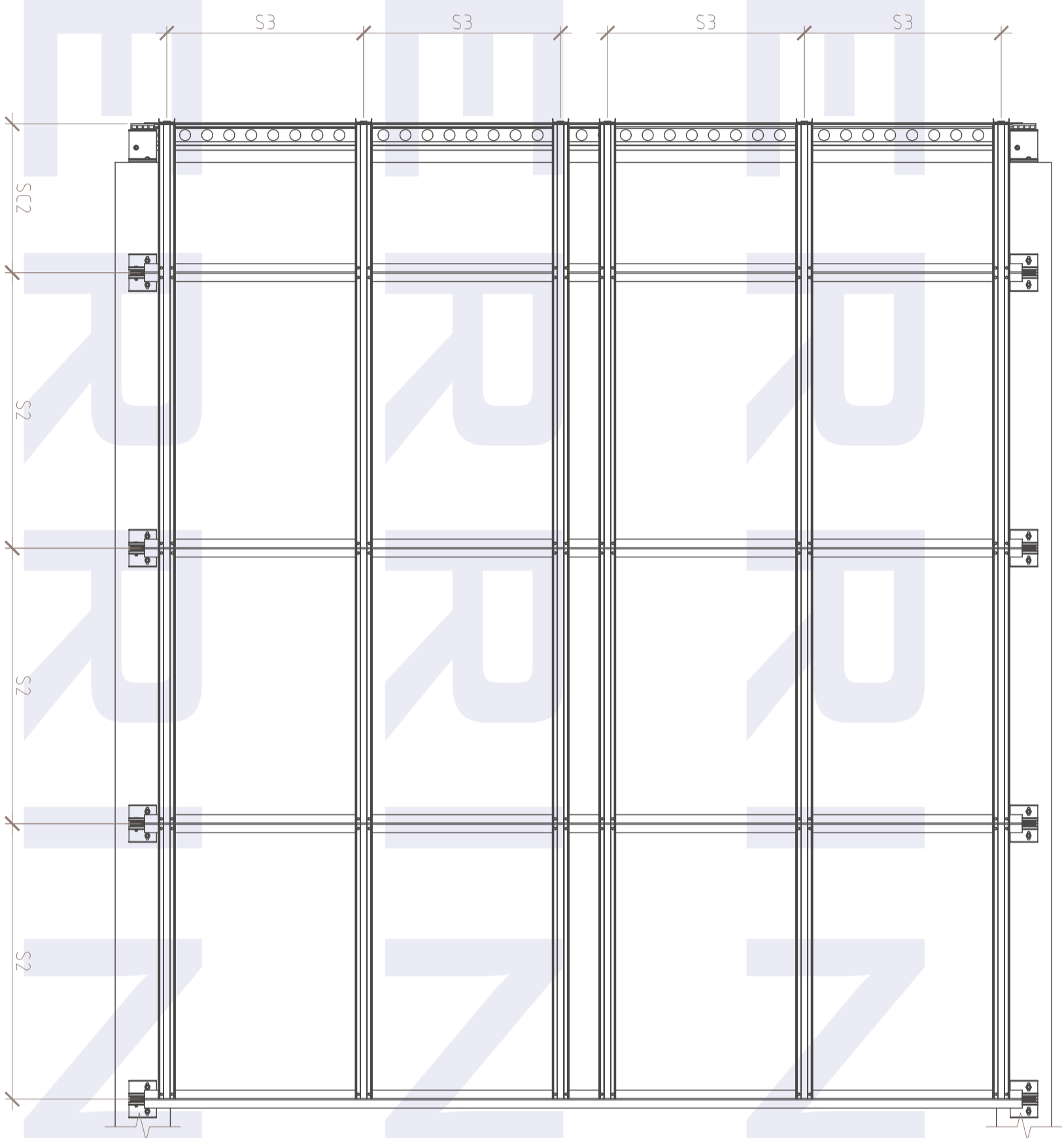

ELEVATION VIEW

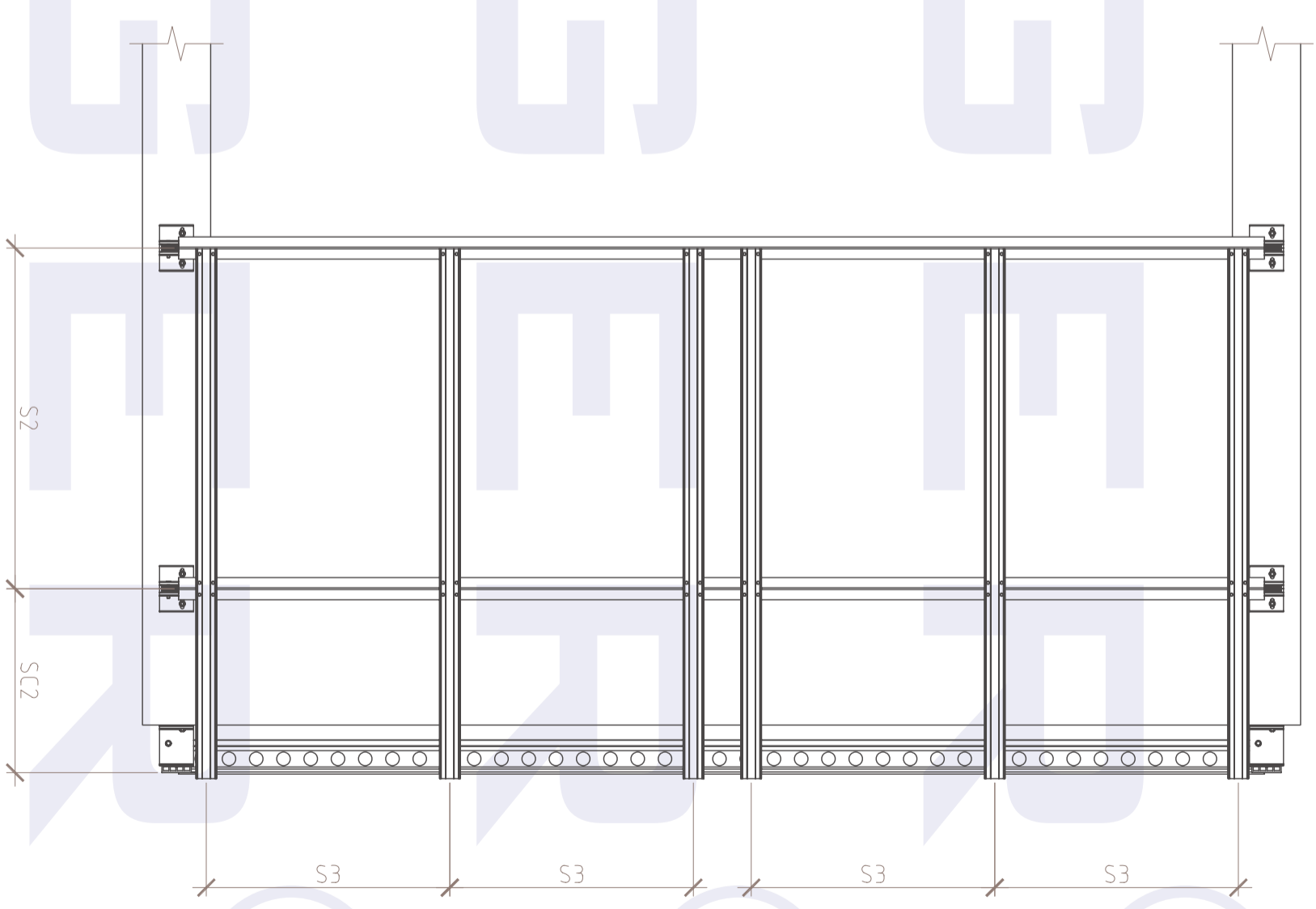

TOP VIEW

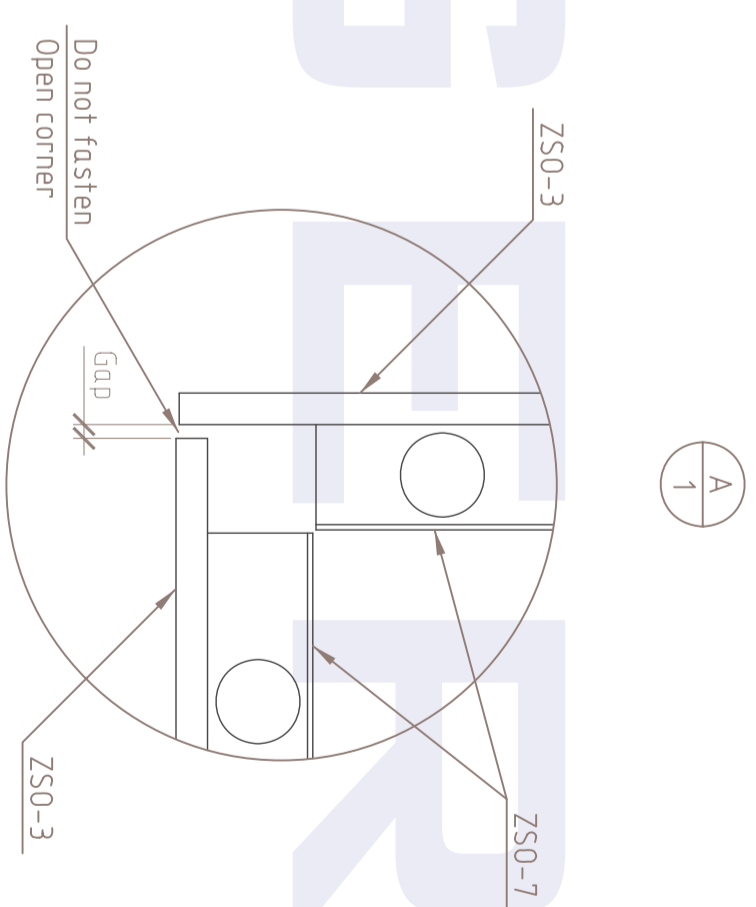
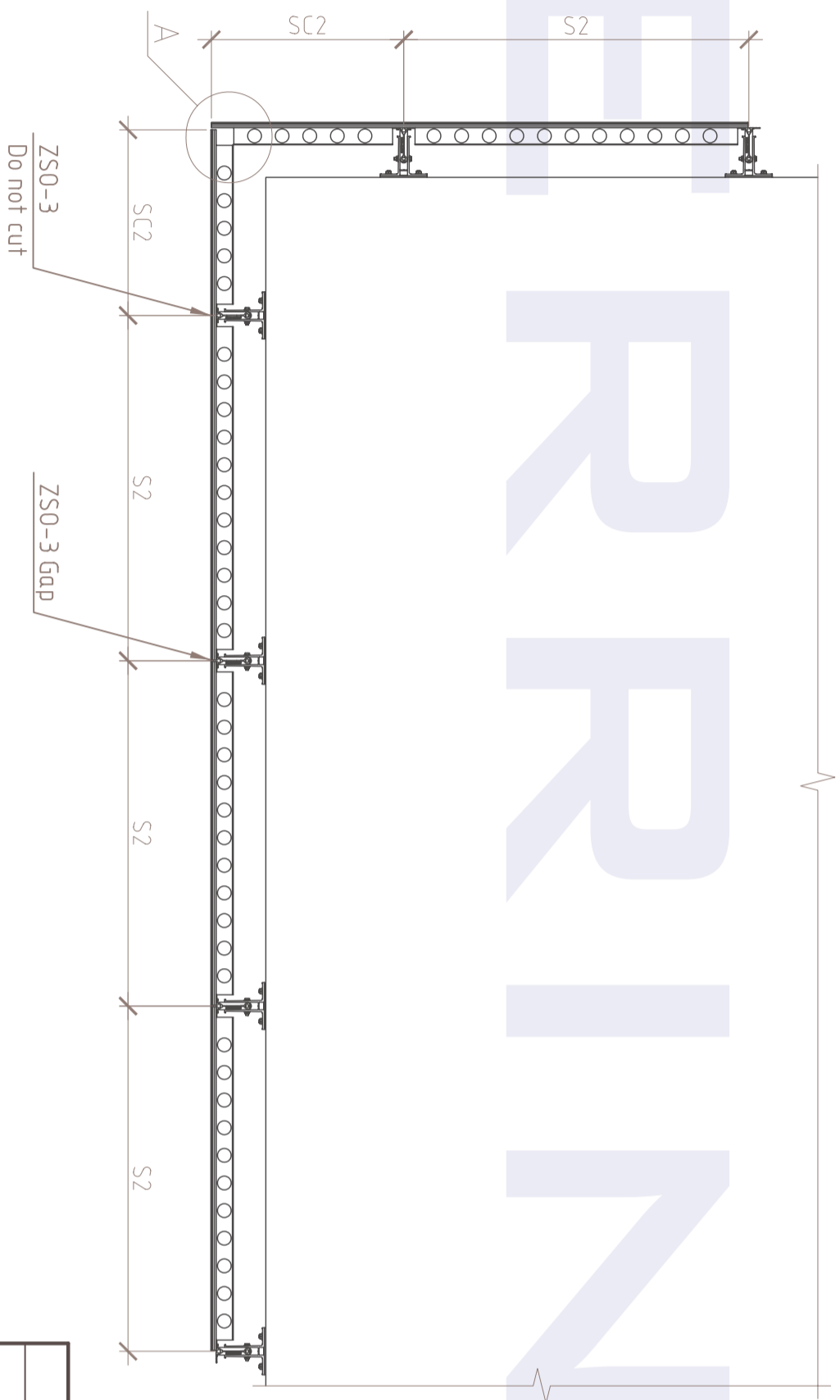

ZERRINGER

ZERRINGER.SnapOn.Epoxy Panel.Subframe

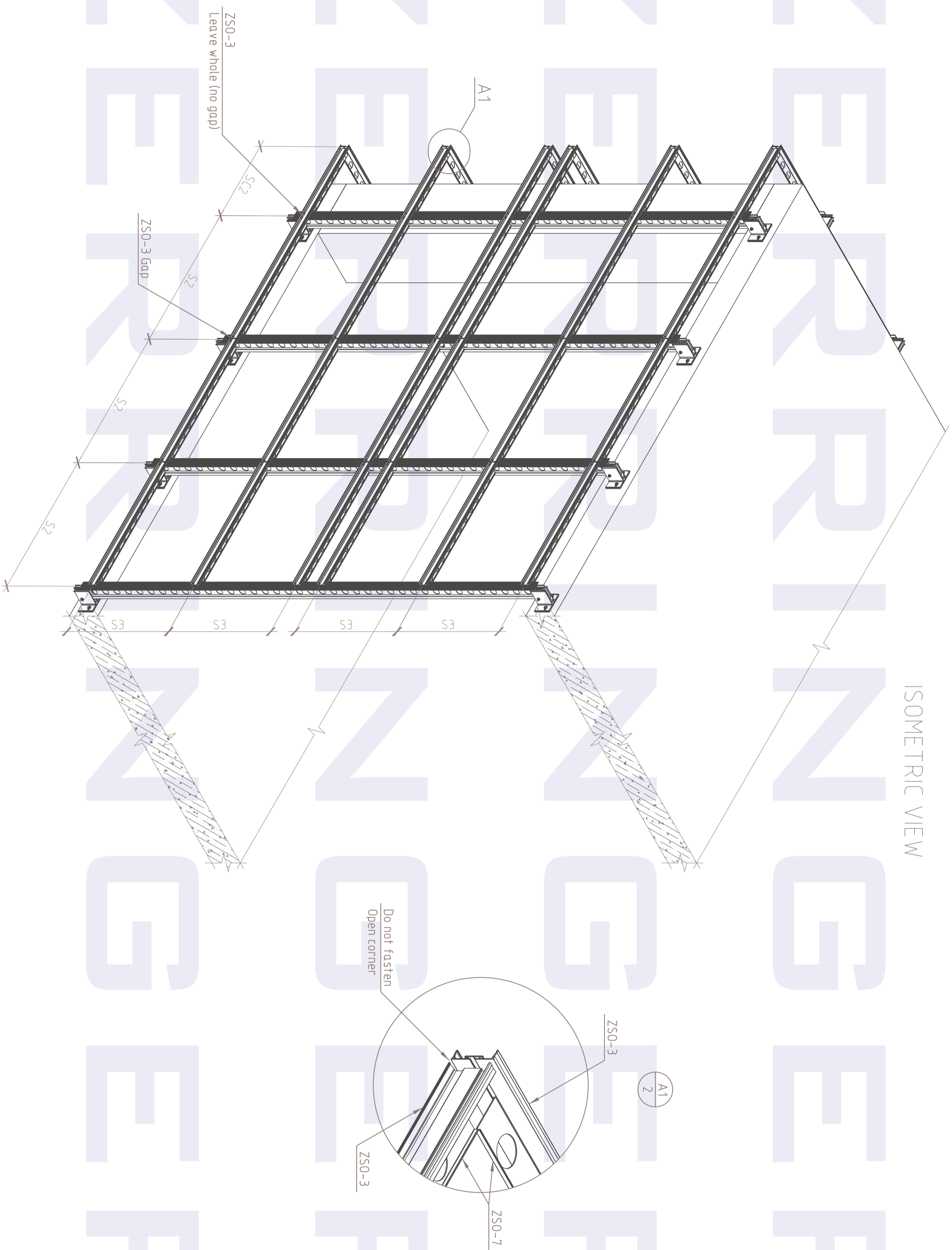

--	--	--	--	--	--	--	--	--	--



Adjusting point

Screw D8xL8
DIN ISO 7050

ZSO-8

Sliding point

ZSO-3

Gap 1
gaskets

ZSO-7

Screw D8xL8
DIN ISO 7050

ZSO-3

Gap 1

ZSO-8

Adjusting point

Rivets D3



E1
4

Adjusting point

ZS0-8

Sliding point

ZS0-7

Panel

ZS0-2

ZS0-3

Adjuster bolt

Gap

ZS0-8

Adjusting point

Gap 1

Panel

ZS0-7

ZS0-3



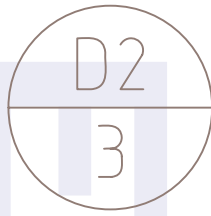

Fixed point

Screw D8xL8
DIN ISO 7050

ZS0-8

Sliding point

W8

Gap 1
gaskets

ZS0-3

ZS0-7

Screw D8xL8
DIN ISO 7050

W8

Gap 1

ZS0-8

Fixed point

ZS0-3

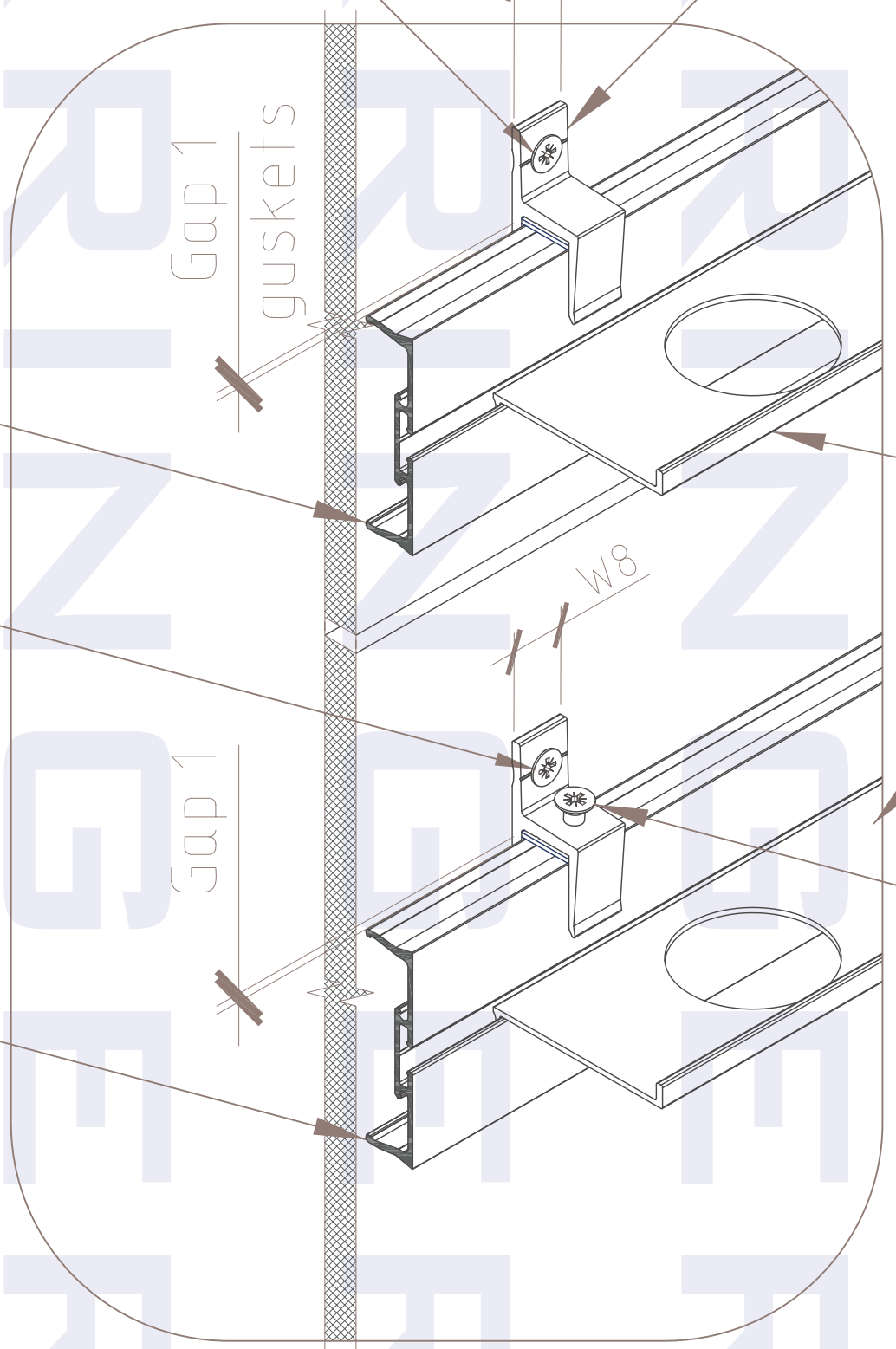

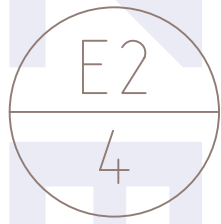

Fixed point

ZS0-8

Sliding point

ZS0-7

Panel

ZS0-2

ZS0-3

Fixing screw
Self-tapped
ZS0-8

Fixed point

Gap

Gap 1

gaskets

Panel

ZS0-7

ZS0-3



A

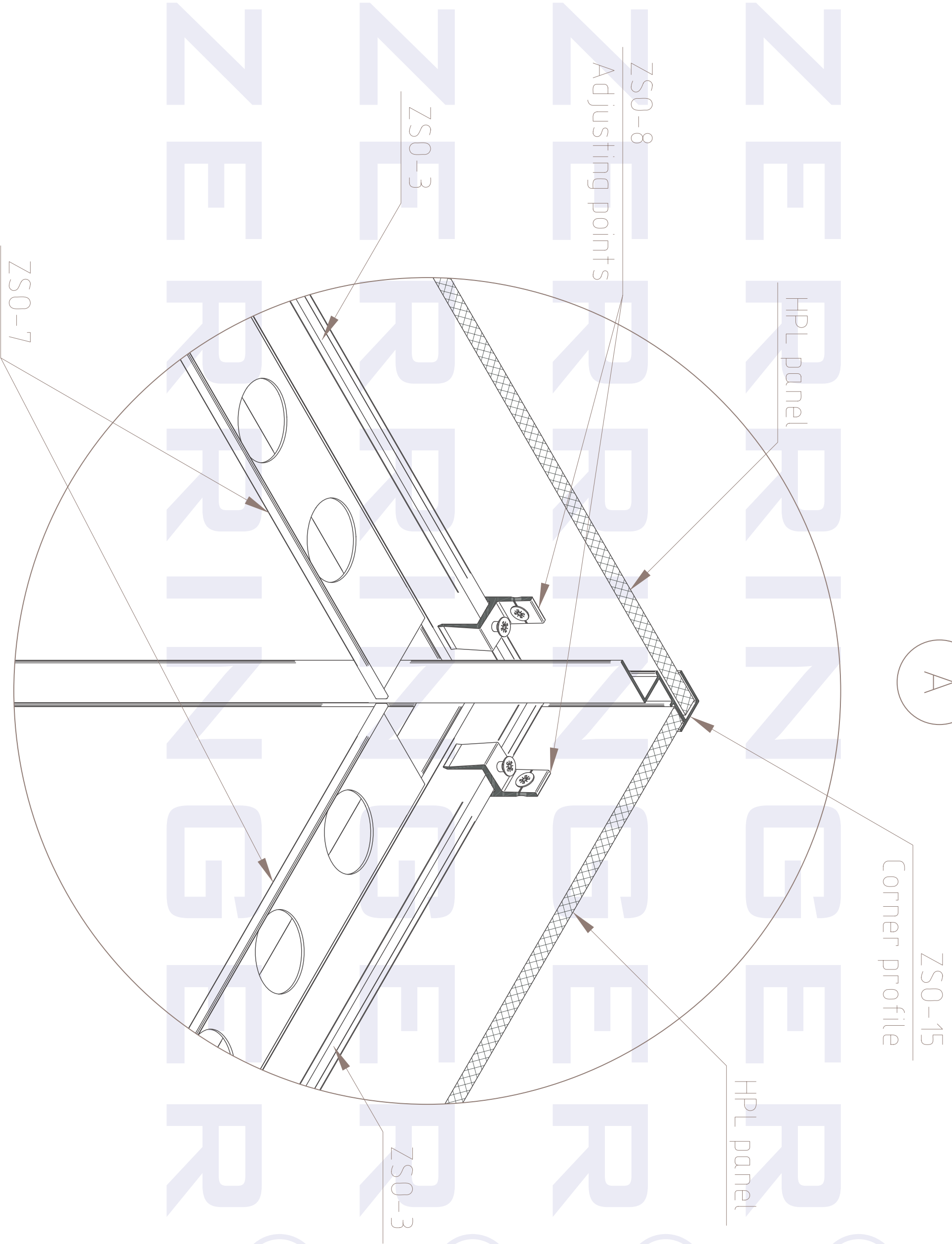

B

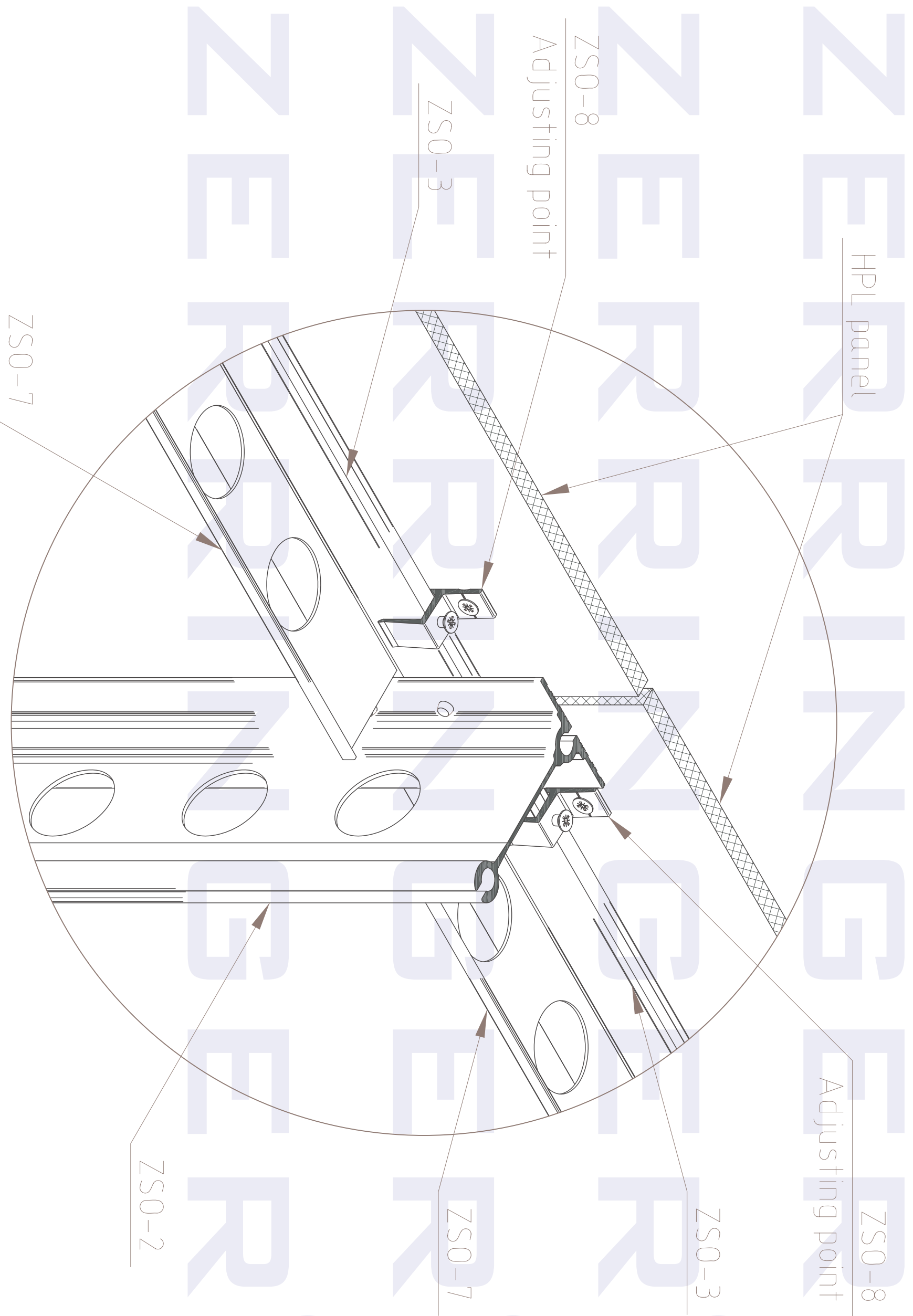

ELEVATION VIEW (blank wall)

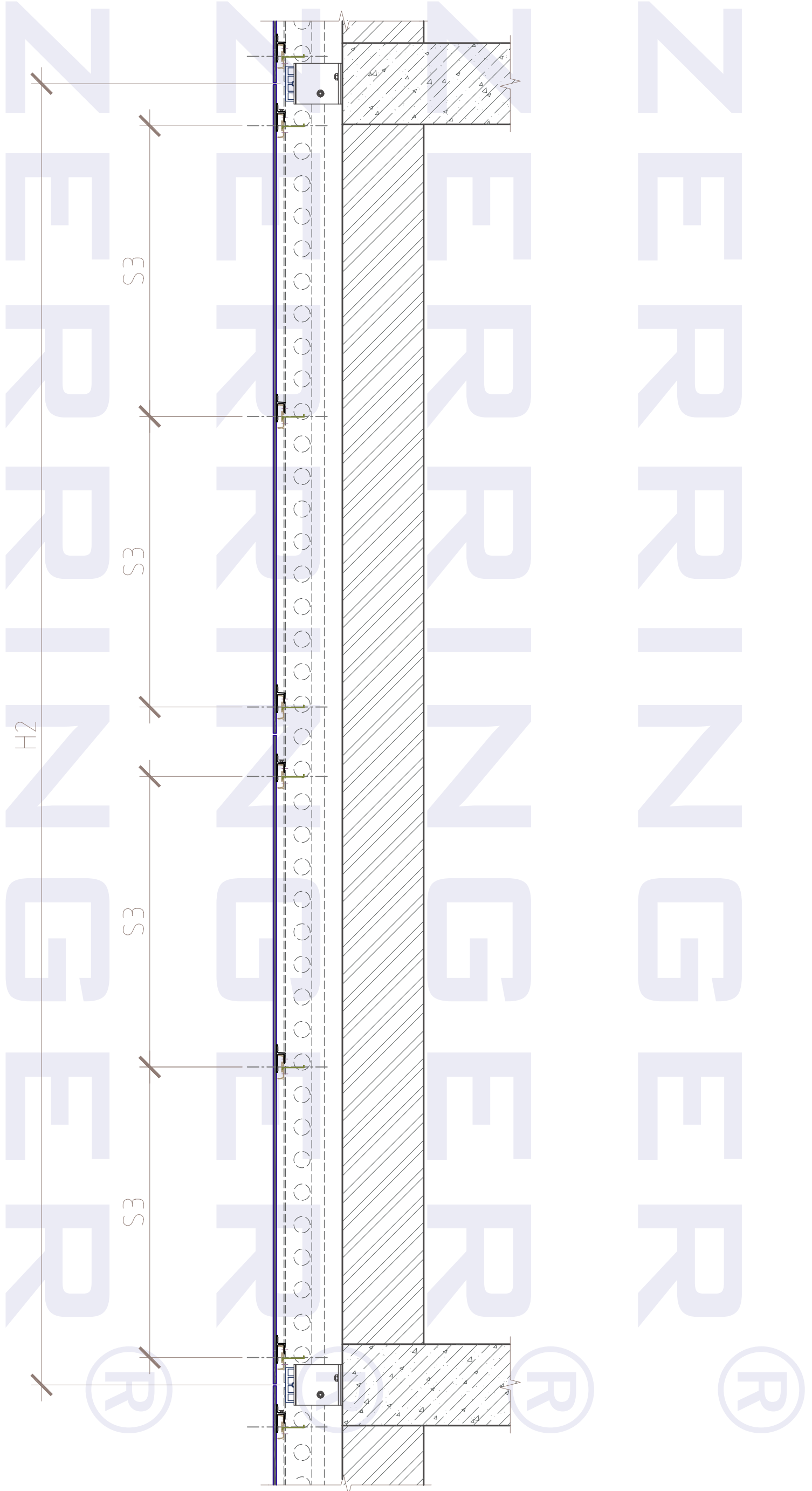

ELEVATION VIEW
(wall with window opening)

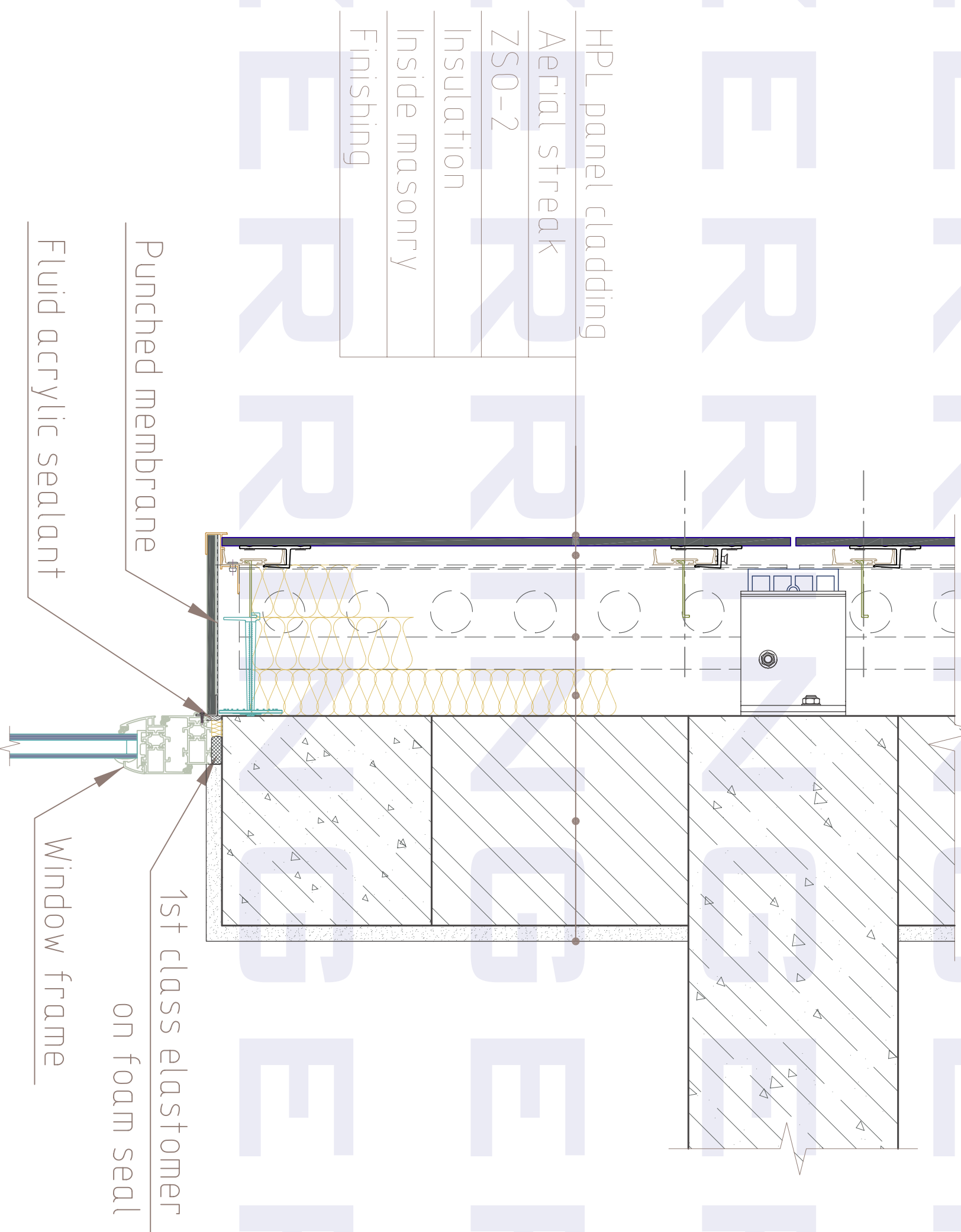

ELEVATION VIEW

(wall with window opening)

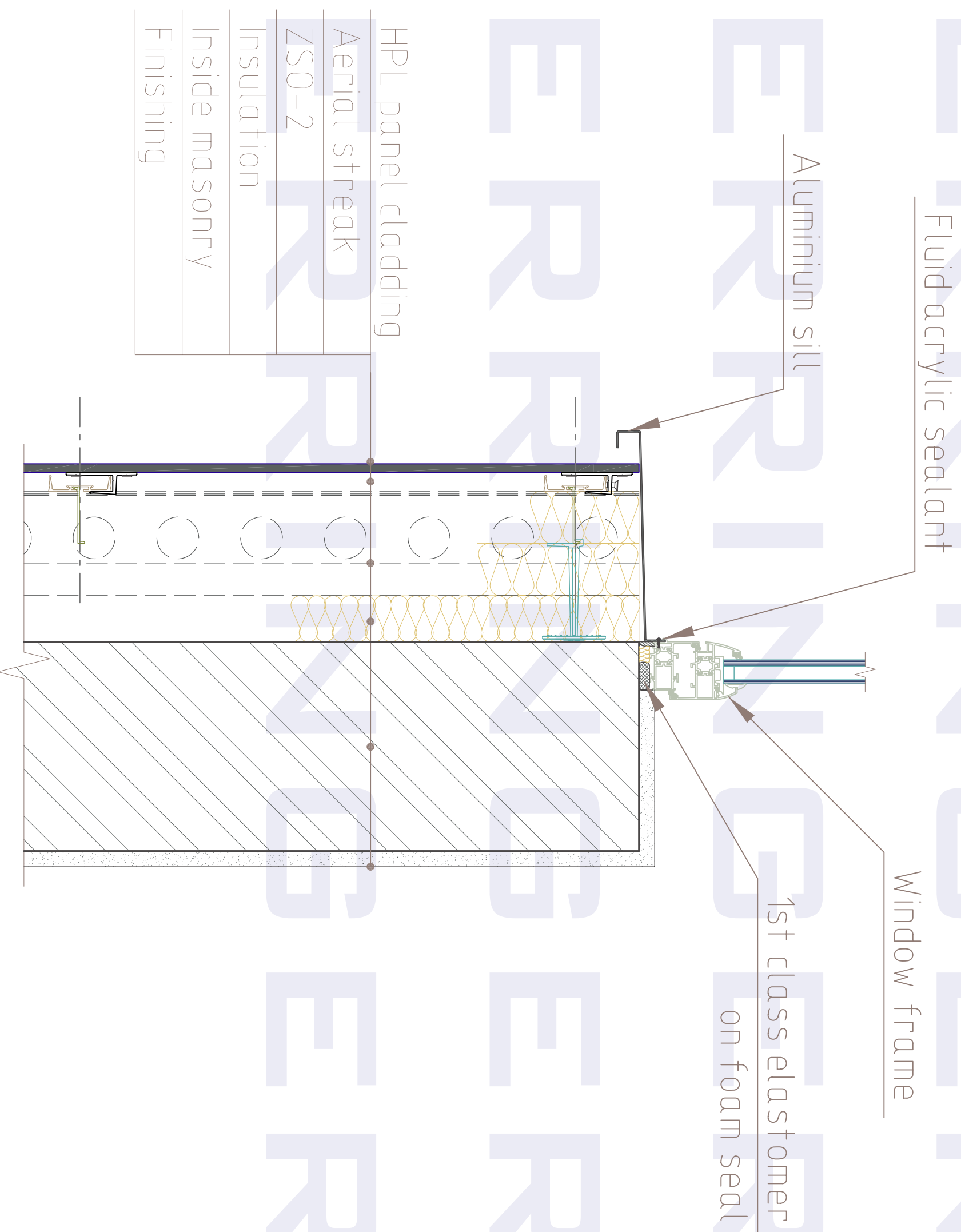

TOP VIEW
(window opening)

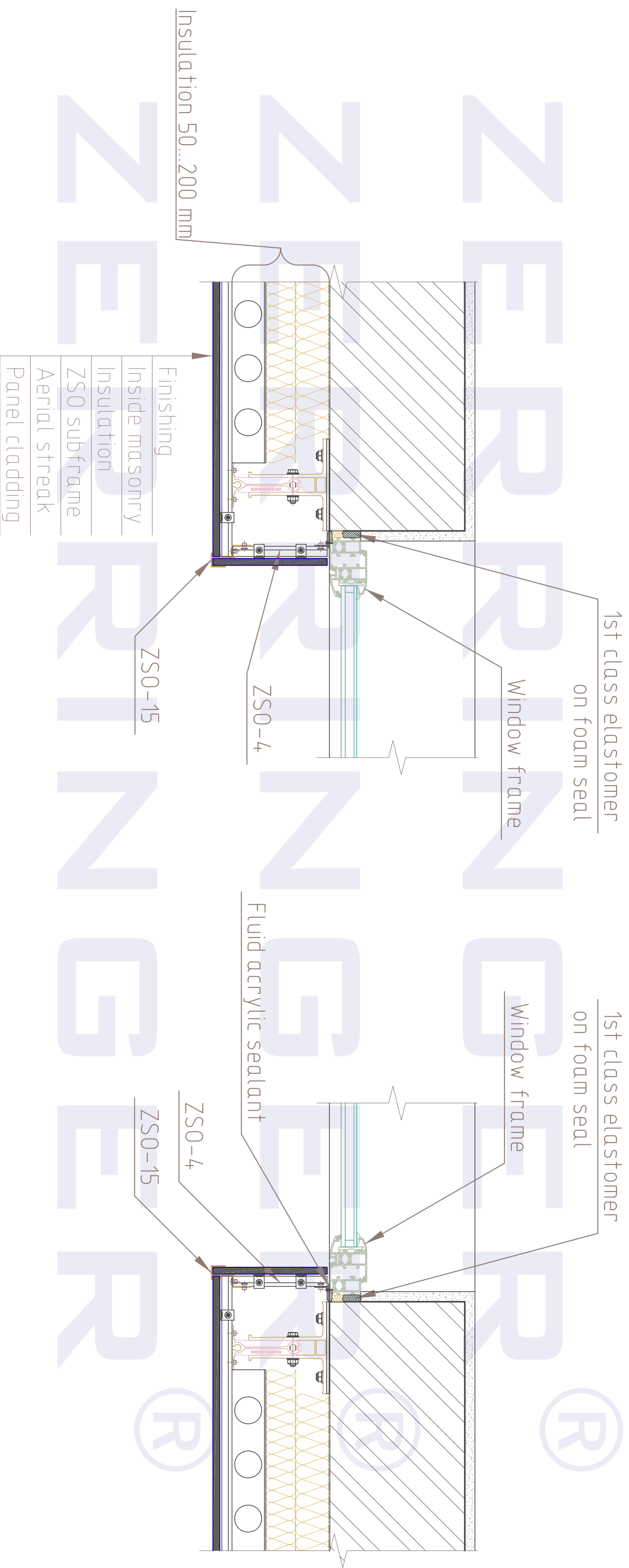

ELEVATION VIEW
(parapet)

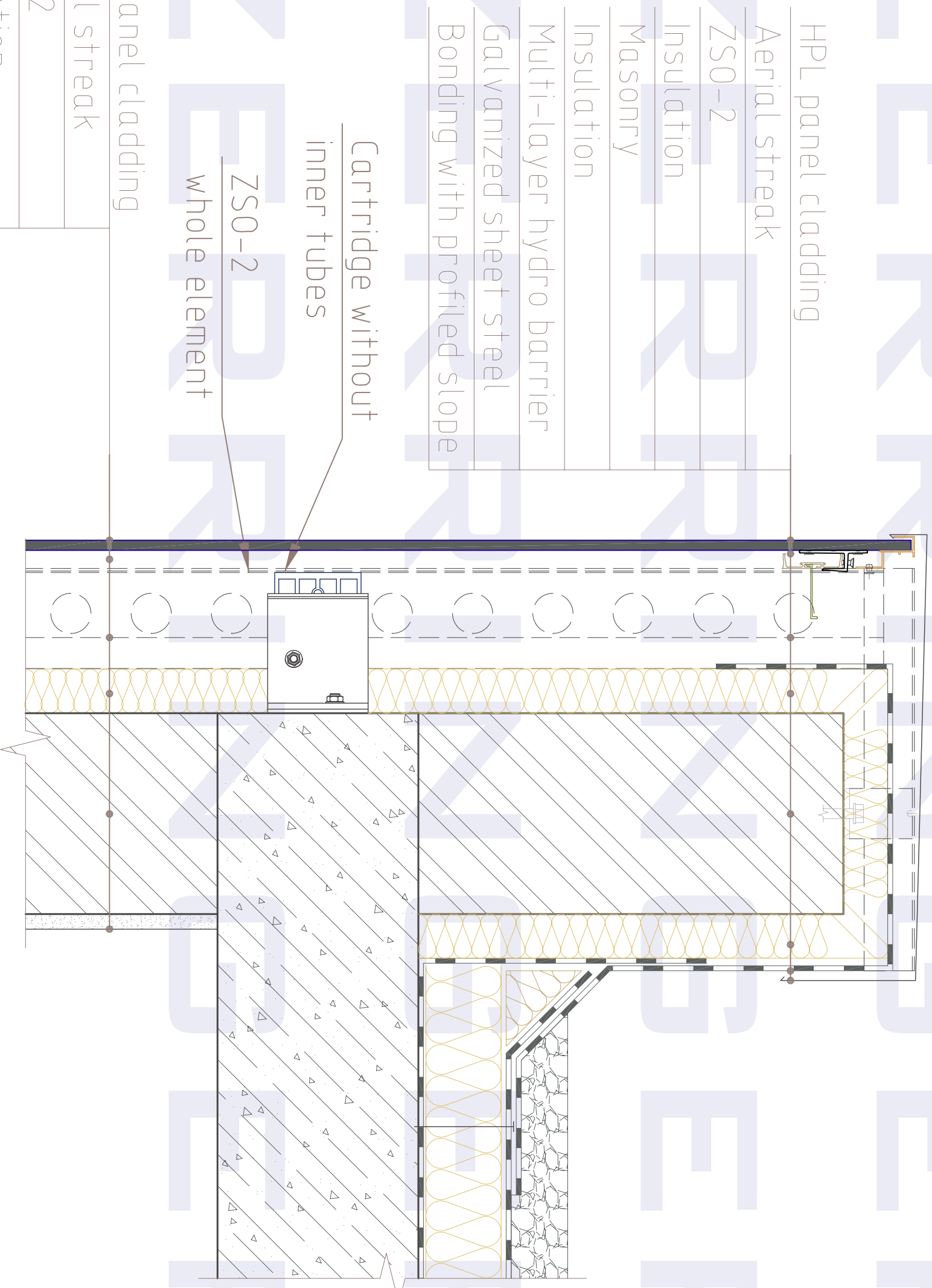

HPL panel cladding
Aerial streak
ZS0-2
Insulation
Inside masonry
Finishing

Cartridge without
inner tubes
ZS0-2
whole element

HPL panel cladding
Aerial streak
ZS0-2
Insulation
Masonry
Insulation
Multi-layer hydro barrier
Galvanized sheet steel
Bonding with profiled slope

ELEVATION VIEW
(overlapping detail)

- HPL panel cladding
- Aerial streak
- ZS0-2
- Insulation
- Inside masonry
- Finishing

Expansion gap

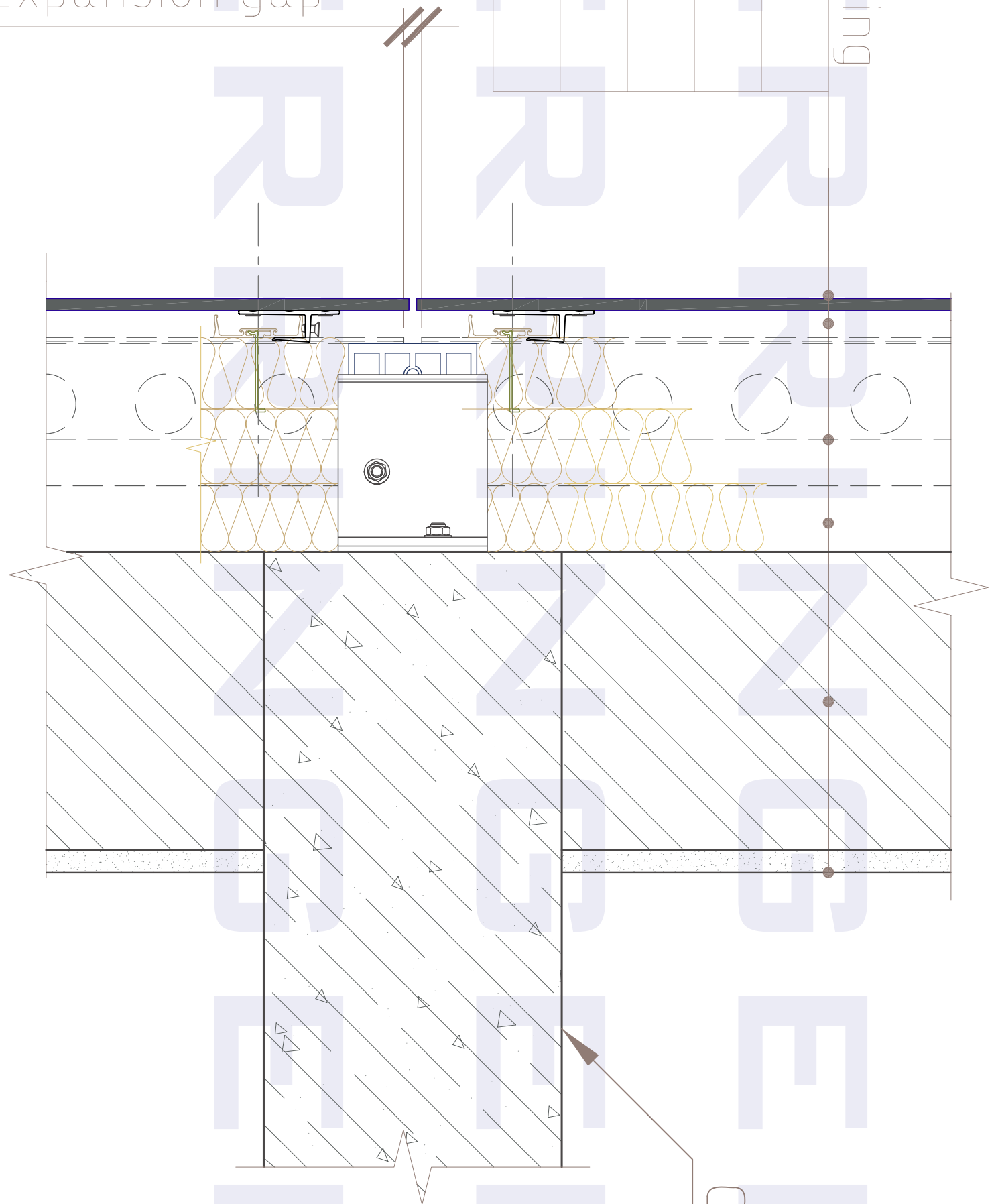

Concrete slab

ELEVATION VIEW (basement)

- HPL panel cladding
- Aerial streak
- ZSO-2
- Insulation
- Masonry
- Finishing

- HPL panel cladding
- Aerial streak
- ZSO-2
- Insulation
- Masonry
- Finishing

Perforation

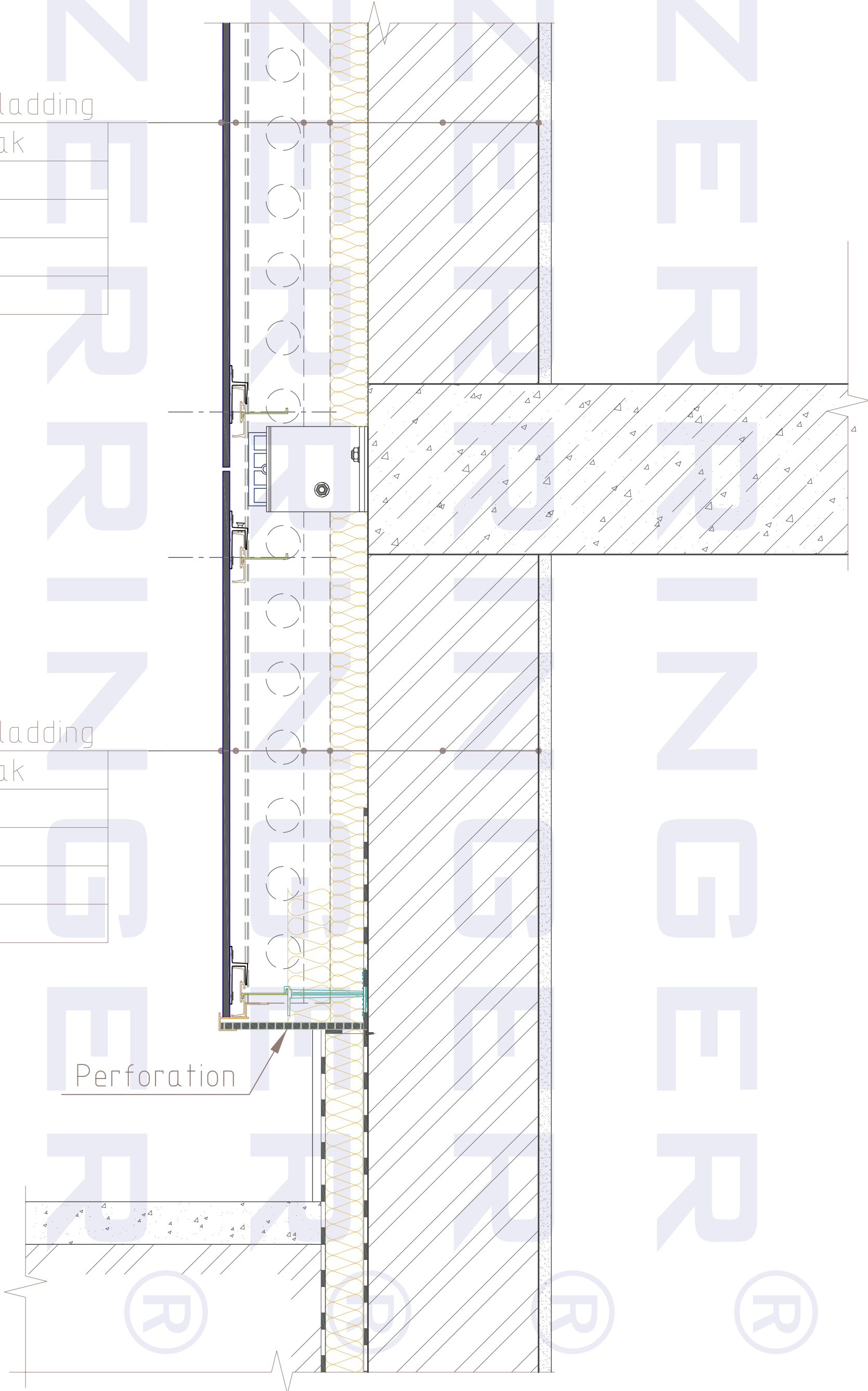

ELEVATION VIEW (balcony)

HPL panel cladding
Aerial streak
ZSO-2
Insulation
Masonry
Finishing

Aluminium bend sheet

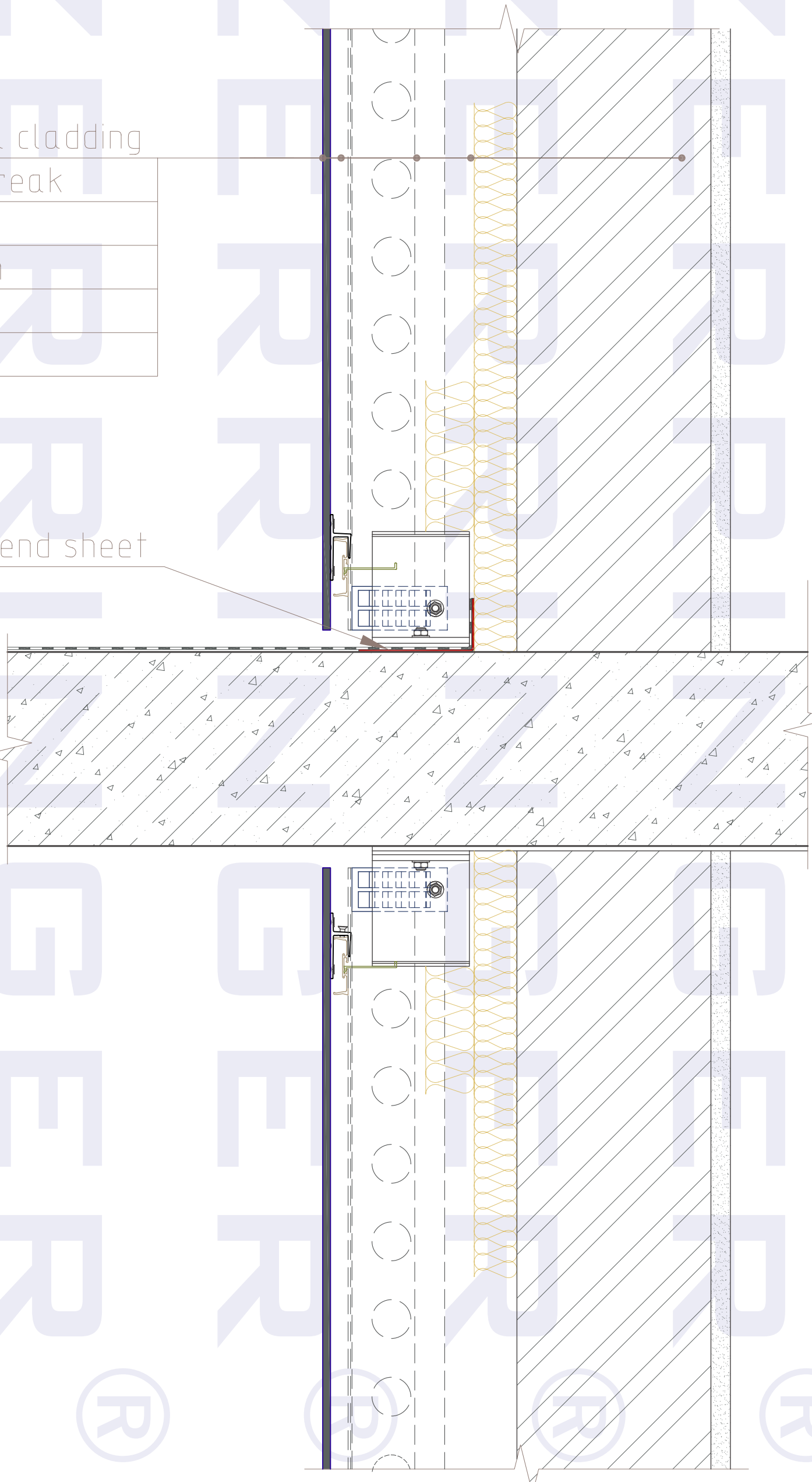
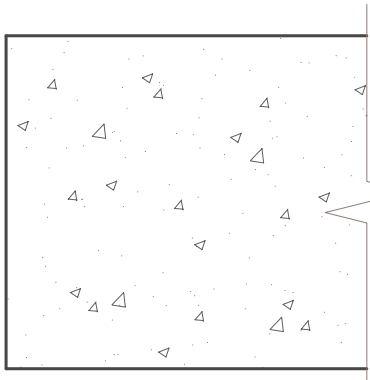

ELEVATION VIEW (balcony)

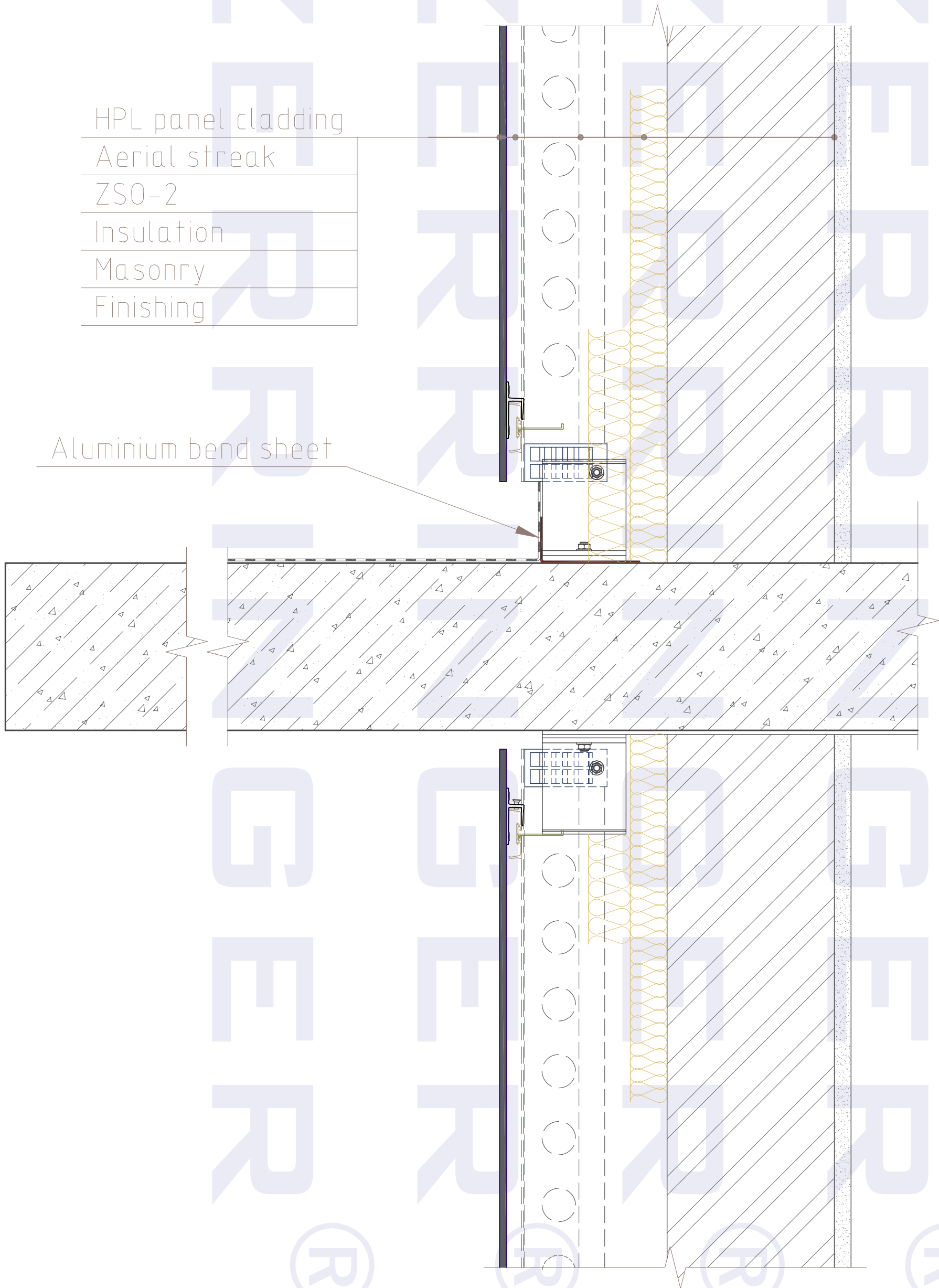

TOP VIEW - external corner
(open corner)

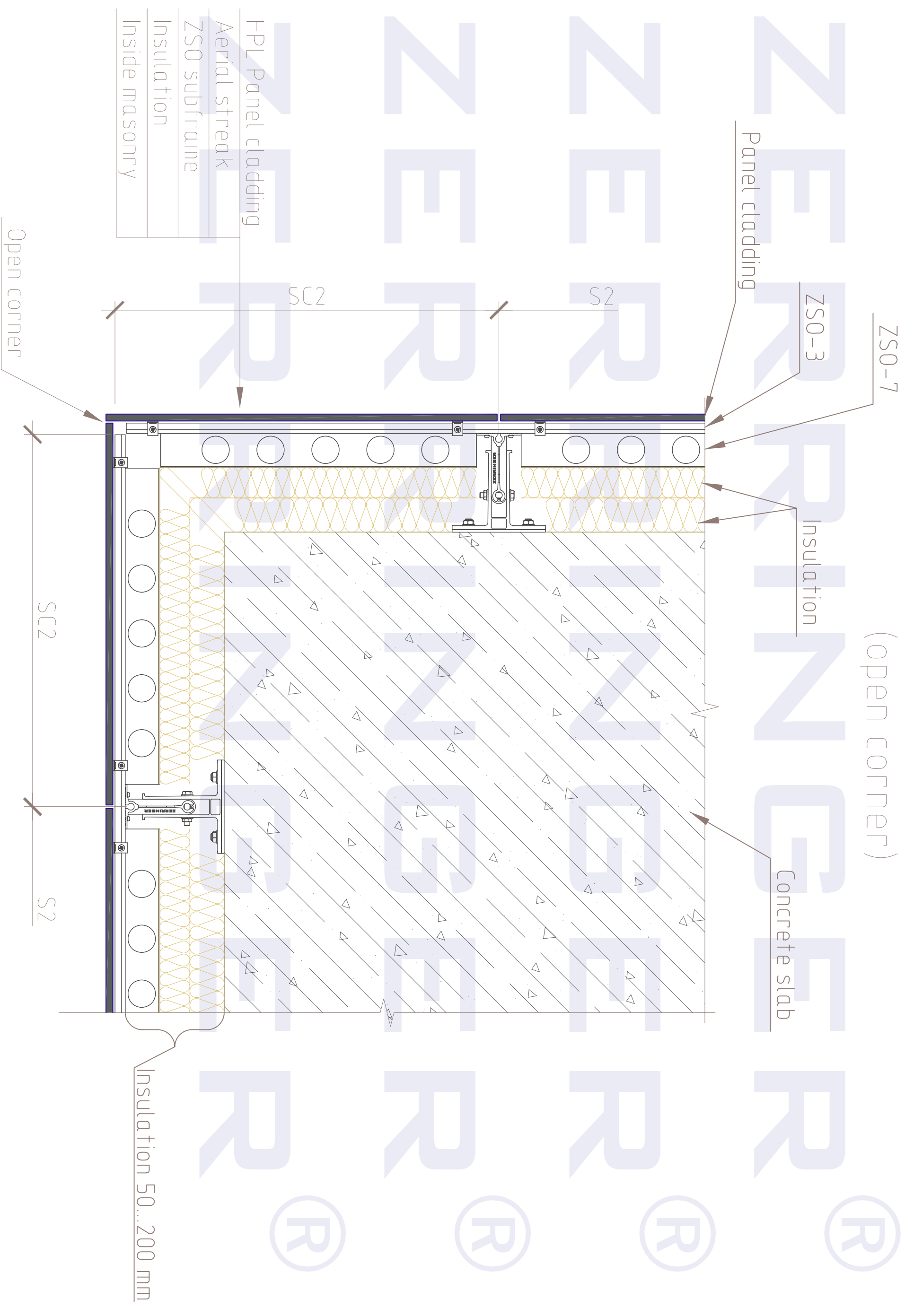

TOP VIEW - internal corner
(open corner)

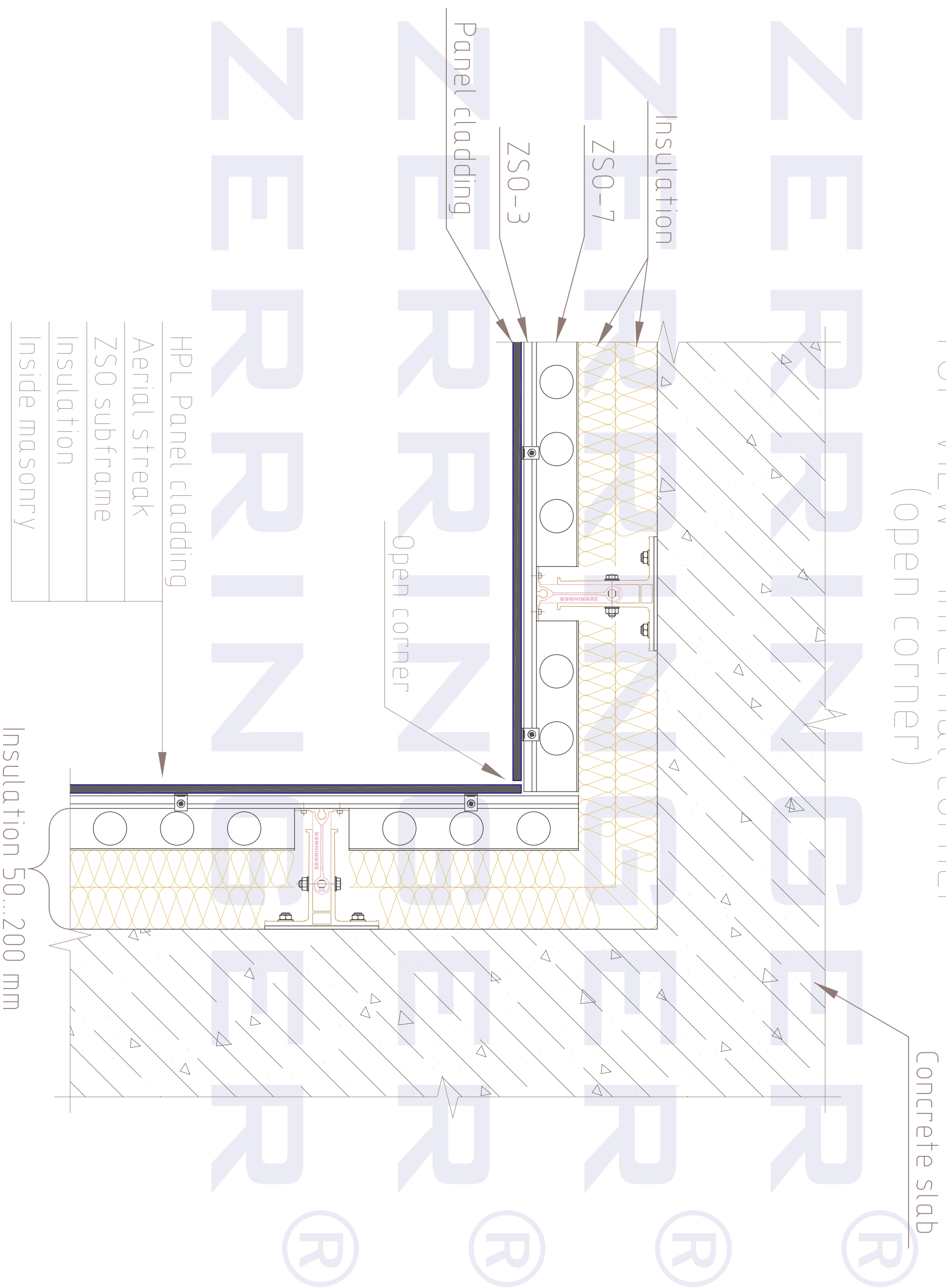

TOP VIEW - internal corner
(corner profile)

Concrete slab

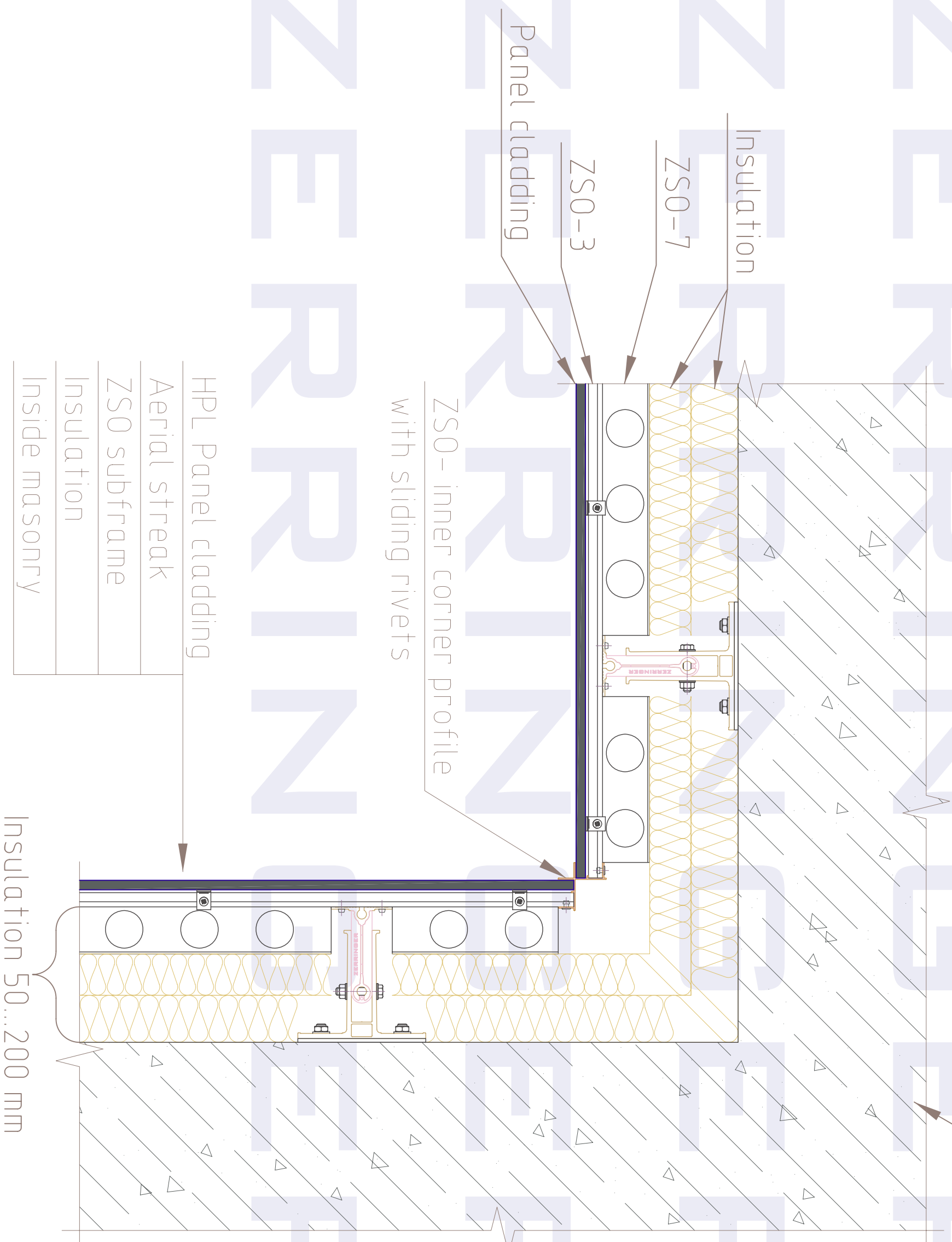

Panel cladding

Insulation

ZSO-7

ZSO-3

ZSO - inner corner profile
with sliding rivets

HPL Panel cladding
Aerial streak
ZSO subframe
Insulation
Inside masonry

Insulation 50...200 mm

TOP VIEW - external corner
(trespa corner profile element)

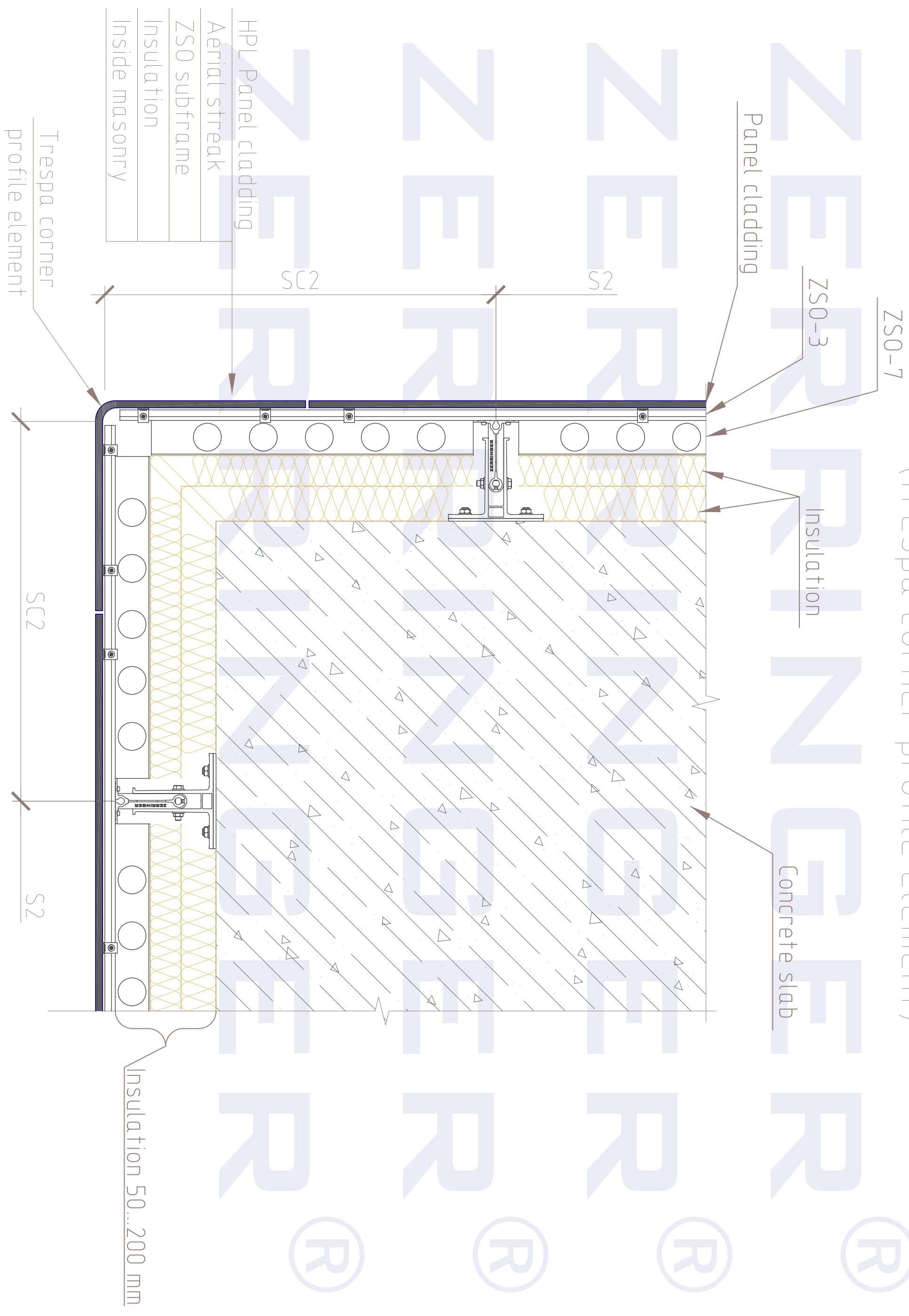

TOP VIEW - internal corner
(trespa corner profile element)

Concrete slab

